

2018 Product Guide



WALDEN
PREMIER

WOVEN WOOD MATERIALS REFERENCE

PATTERN CODE	PATTERN NAME	PRICE GROUP	EDGE BINDING	SLIDING PANEL	COORDINATED WAND COLOR	MAXIMUM SIZE FOR MOTORIZED SHADES (SQUARE FEET)	
						WITHOUT LINER	WITH LINER
E-432	Artisan Weave	D	Y	N	Bronze	44	38
E-416	Aspen Cedar	C	Y	Y	Bronze	44	38
E-416-3	Aspen Ebony	C	Y	Y	Black	44	38
E-082	Aspen Walnut	C	Y	Y	Bronze	44	38
E-416-4	Aspen White	C	Y	Y	White	44	38
E-H33	Baja Walnut	C	Y	Y	Bronze	64	56
E-R26	Bamboo Forest	B	Y	Y	Bronze	44	38
E-05B	Bamboo Leaf Brown	D	Y	Y	Bronze	44	38
E-365	Barcelona Café	B	Y	Y	Bronze	54	44
E-363	Barcelona Dusk	B	Y	Y	Black	54	44
E-006	Boardwalk	A	Y	Y	Beige	56	45
E-861	Bora Bora	B	Y	Y	Beige	50	42
E-405	Borneo Dappled	A	Y	Y	Beige	44	38
E-401	Cape Town	C	Y	Y	Bronze	54	44
E-430	Capri Natural	C	Y	Y	Beige	64	56
E-389	Catalina	D	Y	Y	Beige	64	64
E-361	Devon Coffee	A	Y	Y	Bronze	56	45
E-E11	Devon Ivory	A	Y	Y	Beige	56	45
E-E06	Devon Maple	A	Y	Y	Beige	56	45
E-E02	Devon White	A	Y	Y	White	56	45
E-68N	Driftwood Natural	B	Y	Y	Beige	44	38
E-022	Durban	A	Y	Y	Beige	56	45
E-L42	Fiji Earth	C	N	N	Bronze	56	45
E-L41	Fiji Olive	C	N	N	Bronze	56	45
E-R11	Island Spice	D	Y	N	Bronze	56	45
E-354	Jakarta Spice	C	Y	Y	Bronze	64	49
E-055	Java Cocoa	B	Y	Y	Bronze	54	44
E-55B	Kyoto Brown	B	Y	Y	Bronze	44	38
E-74D	Lattice Twilight	A	Y	Y	Black	54	44
E-B01	Mandalay Umber	C	Y	Y	Black	33	30
E-07M	Nassau Mahogany	D	Y	Y	Black	33	30
E-390	Natural Jute	D	Y	Y	Beige	64	56
E-C09	Osaka	B	Y	Y	Bronze	56	45
E-378	Panama Sand	A	Y	Y	Beige	54	44
E-403-B	Penang Oak	A	Y	Y	Bronze	56	45
E-043	Plaza Khaki	B	Y	Y	Bronze	64	49
E-110	Plaza Mahogany	C	Y	Y	Black	64	49

All fabrics have a maximum width of 96".

WOVEN WOOD MATERIALS REFERENCE

PATTERN CODE	PATTERN NAME	PRICE GROUP	EDGE BINDING	SLIDING PANEL	COORDINATED WAND COLOR	MAXIMUM SIZE FOR MOTORIZED SHADES (SQUARE FEET)	
						WITHOUT LINER	WITH LINER
E-042	Plaza Tan	B	Y	Y	Beige	64	49
E-427	Prairie Golden	D	Y	Y	Beige	64	56
E-828	Prairie Snow	D	Y	Y	Beige	64	56
E-350	Prairie Sunset	C	Y	Y	Bronze	64	56
E-428	Prairie White	D	Y	Y	Beige	64	56
E-034	Rangoon	B	Y	Y	Bronze	56	45
E-398	Sahara	B	Y	Y	Beige	54	44
E-001	Sakura Oregano	C	Y	Y	Bronze	54	44
E-352	Savanna Husk	C	Y	Y	Bronze	64	56
E-030	Sedona	C	Y	Y	Bronze	64	49
E-040	Shoji	B	Y	Y	Bronze	56	45
E-369	Sierra Cinnamon	D	Y	N	Bronze	50	42
E-367	Sierra Olive	D	Y	N	Bronze	50	42
E-370	Sierra Sand	D	Y	N	Bronze	50	42
E-381	Split Bamboo	A	Y	Y	Bronze	44	38
E-31C	St Martin Cappuccino	D	Y	Y	Bronze	44	38
E-438	Sunshade Brown	A	Y	Y	Bronze	54	48
E-10H	Sunshade White	C	Y	Y	White	44	38
E-394	Tamarind Sunset	B	Y	Y	Bronze	44	38
E-372	Tradewind Natural	D	Y	Y	Beige	56	45
E-383	Water Reeds	B	N	N	Beige	50	42
E-011-2	Woodweave Brown	D	Y	Y	Bronze	54	44
E-011	Woodweave Espresso	D	Y	Y	Black	54	44

All fabrics have a maximum width of 96".

EDGE BINDINGS

COLOR	COLOR NUMBER	WIDTH	COLOR	COLOR NUMBER	WIDTH
WIDE EDGE BINDING			NARROW EDGE BINDING		
Beige	W3	3"	Beige	N3	1"
Black	W10	3"	Black	N10	1"
Chocolate	W4	3"	Chocolate	N4	1"
Copper	W5	3"	Copper	N5	1"
Cream	W8	3"	Cream	N8	1"
Desert Sand	W6	3"	Desert Sand	N6	1"
Light Beige	W2	3"	Light Beige	N2	1"
Natural	W15	3"	Natural	N15	1"
Sienna	W11	3"	Sienna	N11	1"
White	W1	3"	White	N1	1"

LINERS

COLOR NUMBER	COLOR	MATERIAL	WIDTH
PRIVACY LINERS			
NK-L	Privacy Beige	80% Poly/20% Cotton	55"
NC-L	Privacy Chocolate	80% Poly/20% Cotton	55"
W4-L	Privacy White	80% Poly/20% Cotton	55"
BLACK-OUT LINERS			
K3-D	Black-Out Beige	80% Poly/20% Cotton	55"
C2-D	Black-Out Chocolate	80% Poly/20% Cotton	55"
W4-D	Black-Out White	80% Poly/20% Cotton	55"

Privacy Liners are the same color on both sides.

Black-Out Liners are off-white to the street.

SHADE STYLES

All standard shade styles operate with a cord lock and are supplied with cord cleats to keep the cords tidy and away from children or pets.

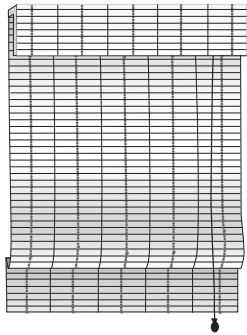
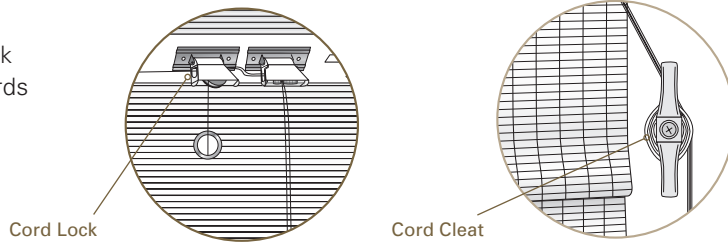

STANDARD ROMAN SHADE

Shade is raised by means of cords, which hang in front of the shade. Includes a 6" valance to conceal the components. When raised, the material rises from the bottom in flat folds.

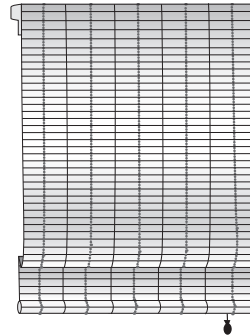

WATERFALL SHADE

Shade is raised by means of cords, which hang behind the shade. Material is attached to the front of the head rail, without a valance. When raised, the material rises from the bottom in flat folds.

Optional back valance is available upon request.

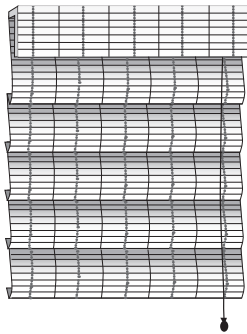

HOBBLED SHADE

Shade is constructed the same way as a standard roman shade, with a 6" valance and cords in front of the shade. When lowered, the shade maintains its folds, giving it a soft fabric look.

NOTE: *Hobbled shades contain more material and so are heavier than the standard roman and waterfall shades.*

VALANCE RETURNS

Valance returns are supplied with all outside mount shades. They are also available upon request with inside mount shades.

Standard valance returns are the same length as the valance: 6" long. They are made of the chosen bamboo pattern.

Short valance returns (2" long) are available upon request. Short returns conceal the end of the head rail and components; they remain clear of the shade when it is fully raised.

FABRIC VALANCE RETURNS

For shades with edge binding, returns made from the edge binding fabric are available as a surcharge option.

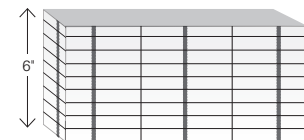

6" Standard Valance Return

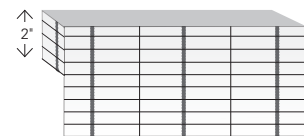

2" Short Valance Return

SHADE OPTIONS

LINERS

A liner can be ordered attached to the back of the shade or as a separately operable, movable liner (see Twin Shade below).

ATTACHED LINERS

Attached liners are available in privacy or black-out. They are secured to the back of the shade by stitches at each side of the liner. If a shade is lined, the valance will automatically be lined with the same material.

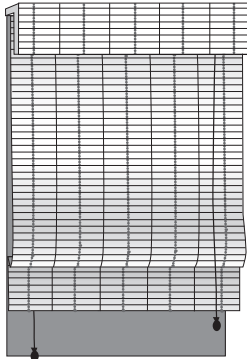

shown with controls on opposite sides

TWIN SHADE

Features two separate, independently operated shades on one head rail. The front shade can be either a standard or waterfall woven wood shade.

A separate liner shade is attached to the back of the head rail and both shades operate independently. Lift cords can be on the same side (factory standard) or opposite sides of the shade.

Available with Roll Ease® clutch control for the front, woven wood shade, or for both shades.

See Specifications for head rail sizes.

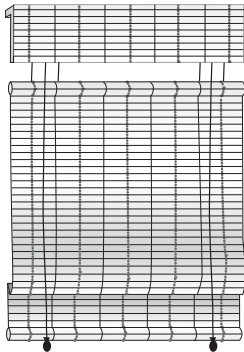

controls always on opposite sides

TOP-DOWN BOTTOM-UP SHADES

Top-Down Bottom-Up (TDBU) shades can be raised from the bottom or lowered from the top. This is accomplished with two separate sets of control cords positioned at opposite sides of the shade. Available with liners and edge binding.

To conceal the cord locks and pulleys each shade will be finished with a 6" lined valance. This is included in the TDBU surcharge.

The maximum width for TDBU shades is 84". TDBU shades are not available in waterfall style, or as multiple shades on one head rail.

MULTIPLE SHADES ON ONE HEAD RAIL

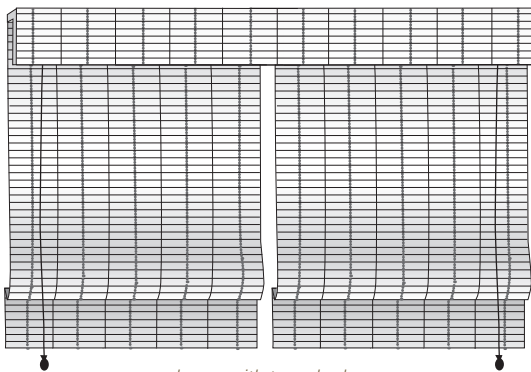

shown with two shades

Shades are available with 2-on-1 or 3-on-1 head rail. The maximum total width is 115" and the gap between shades will be no more than 1/2". The maximum width for a common valance is 96"; wider valances will be made in sections to match the individual shade widths.

Cord locks, clutches, cordless controls and motorization (wand or remote) can be used for these shades. Pay careful attention to make sure there are suitable locations for cord tensioners or cord cleats when specifying multiple shades on one head rail, particularly for the middle shade in 3-on-1 head rail units.

It is possible to operate two shades with just one clutch. A 2-on-1 shade can be specified with only one control on one side of the head rail. A 3-on-1 shade can be specified with only two controls, one on each side of the head rail.

SHADE CONTROL OPTIONS

CLUTCH CONTROL AND CONTINUOUS CORD LOOP (CCL)

Clutch controls are available with all shade styles except TDBU. All clutch control shades come with cord tensioners, which should be securely fixed to the wall to allow for the shade to operate freely and to keep dangerous hanging loops away from children and pets.

Cord loops are available in one foot increments from 2' to 8'. The factory will choose the length closest to $\frac{2}{3}$ shade height, unless otherwise requested. Metal chain loops are available and can be made to custom lengths as a surcharge option.

The stack thickness on longer shades can interfere with both cord loop operation and cord tensioner installation, particularly for outside mount applications. We recommend ordering clutch control shades "cord adjacent;" this means the head rail and valance will be made $\frac{5}{8}$ " wider than the shade on the control side allowing the chain to hang to the side of the shade. Please specify when ordering if you would like the shade to be completed as "cord adjacent."

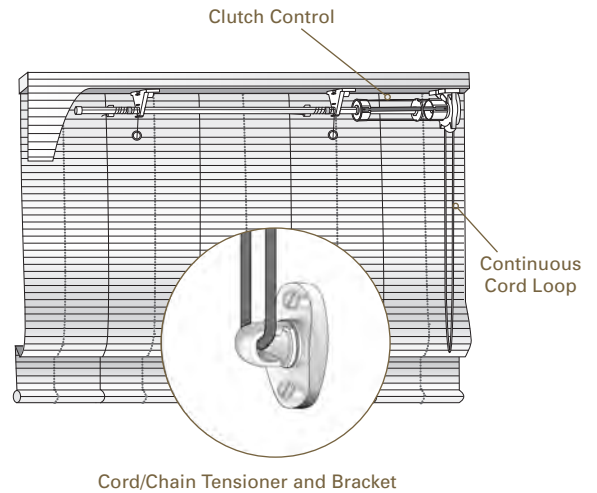

Cord/Chain Tensioner and Bracket

CORDLESS SHADES

Cordless shades operate with no lift cords on the front of the shade. The shade is lowered by pulling on the hem bar. A spring control system, located under the wooden head rail, holds the shade in place at any desired position.

The cordless option is not available on TDBU shades; hold down brackets cannot be used with cordless shades.

Cordless shades are available up to 96" wide and 96" long and will be mounted on standard depth head rails (see Specifications for details).

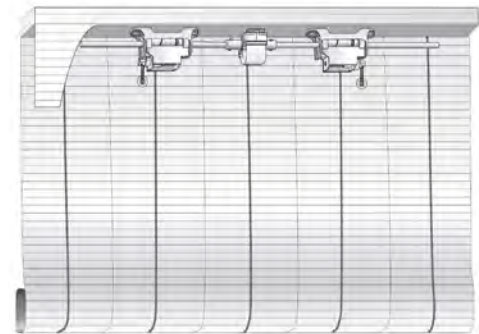

Cordless Shade

MOTORIZED SHADE OPTIONS

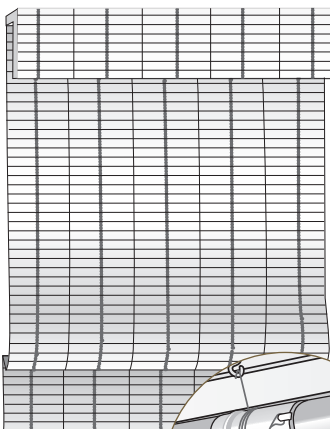

Remote Control Shade

Motor Tube and Spindle

REMOTE CONTROL SHADES

Remote control motorized shades are powered by an internal lithium-ion battery. Operation of the shade is controlled by either a single- or multi-channel radio frequency remote.

The single-channel remote can operate up to 20 shades in one group, with a range of about 100 feet. The multi-channel remote has 15 channels and is recommended to operate shades of different lengths. Wall switches are an available alternative to the remotes.

The motor battery is recharged using an AC power adaptor, which plugs into a port in the motor head.

A solar panel charger alternative is also available; once properly installed it is a permanent power source. *Some restrictions apply.*

Check the Materials Reference table for the maximum size of shade which can be operated by this battery motor.

AC Motors can be specified for larger shades. Please call for specifications/quotes.



Remote Control

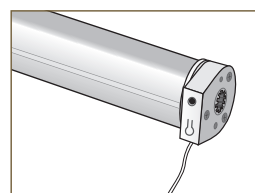

Charging Port in Motor Head

SHADE CONTROL OPTIONS

WAND CONTROL SHADES

Wand control motorized shades are powered by the same internal lithium-ion battery as remote control shades. The motor is controlled using a wand which hangs down to the side of the shade.

Waterfall shades cannot be ordered with wand controls.

Wands are available in 4 lengths: 24", 36", 48" and 60".
Available colors include: white, beige, gray, bronze and black.
See image on page 17.

Wand control shade motor batteries are recharged via a mini USB power adaptor which plugs into the end of the wand.

Check the Materials Reference table for the maximum size of shade which can be operated by this battery motor.

All wand control shades will be made with the head rail and valance $\frac{5}{8}$ " wider than the shade fabric on the control side allowing the wand to hang to the side of the shade. This may cause a light gap on black-out shades.

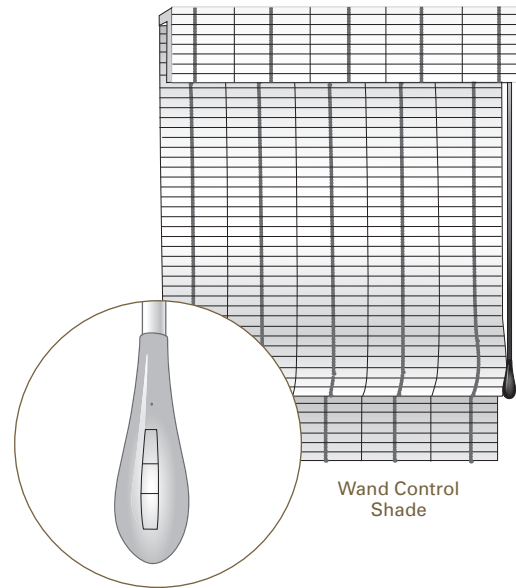

Wand Control Shade

OUTSIDE MOUNT

The shade fabric will be made at the ordered width.

The head rail and valance will be **$\frac{5}{8}$ " wider** on the control side.

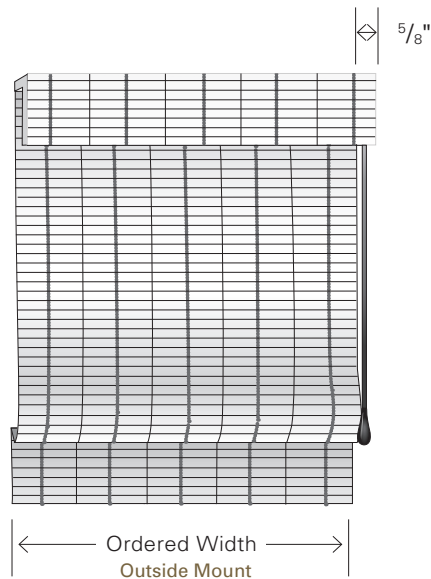

INSIDE MOUNT

The shade, head rail and valance will be made with a $\frac{3}{8}$ " IB deduction.

The shade fabric will be cut an extra **$\frac{5}{8}$ " narrower** on control side.

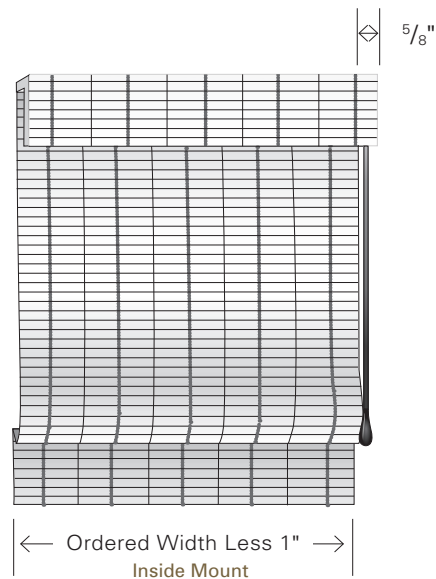

SHADE ADDITIONAL OPTIONS

ADDITIONAL OPTIONS

LINED VALANCE

Lined valances are recommended to conceal the head rail components where an open-weave pattern is selected. All TDBU shades are made with lined valances as standard.

EDGE BINDINGS

Available in two widths: 1" ($\frac{1}{2}$ " on the face of the shade) and 3" ($1\frac{1}{2}$ " on the face of the shade).

Edge binding is applied to the sides of both the shade and valance. It is not applied to the bottom of either.

Hold down brackets can be requested for edge bound shades unless they are finished with cordless control.

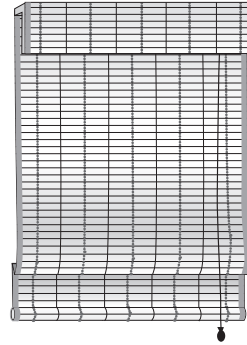

Standard Shade
shown with narrow edge binding

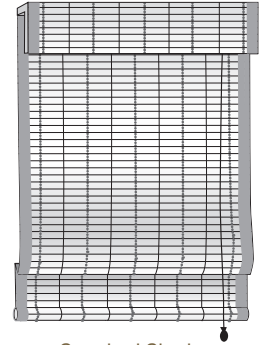

Standard Shade
shown with wide edge binding

CUT OUTS

Cut outs can be taken from either side of the shade. Please provide exact dimensions and the locations of cut outs required.

Cut outs are not available with edge binding.

There may be limitations to what can be cut out, based upon the size and specifications of the shade. The factory will review all orders for cut outs and provide confirmation of each order within 24 hours.

BRACKETS AND SPACER BLOCKS

Hold down brackets are supplied upon request for all but cordless shades.

Spacer blocks measuring $\frac{3}{8}$ " are available upon request. Maximum of 2 spacer blocks per bracket recommended.

SHADE SPECIFICATIONS

	MINIMUM WIDTH	MAXIMUM WIDTH	MINIMUM HEIGHT	MAXIMUM HEIGHT	IB DEDUCTION (WIDTH)	FLUSH IB DEPTH (top mount w/brkt)	MINIMUM IB DEPTH (top mount w/brkt)
STANDARD (CORDED)	12"	96"	18"	108"	3/8"	2 1/2"*	3/4"
NARROW HEAD RAIL (CORDED)	12"	96"	18"	108"	3/8"	2"*	3/4"
CLUTCH and CCL	18"	96"	18"	108"	3/8"	3 3/4"*	3/4"
CORDLESS	18"	96"	18"	96"	3/8"	2 1/2"*	3/4"
TOP-DOWN BOTTOM-UP (TDBU)	12"	84"	18"	108"	3/8"	2 1/2"*	3/4"
REMOTE CONTROL	23"	96"	18"	108"	3/8"	3 3/4"*	3/4"
WAND CONTROL	23"	96"	18"	108"	3/8"	3 3/4"*	3/4"
MULTIPLE SHADES ON ONE HR	-	115" total	-	-	-	-	-
COMMON VALANCE	-	96"	-	-	-	-	-

* Flush IB depth is head rail depth plus 1" when using standard bracket. Exact measurement will vary slightly based upon fabric thickness.

BRACKET DIMENSIONS

Height: 1 1/2"
Depth: 1 3/4"

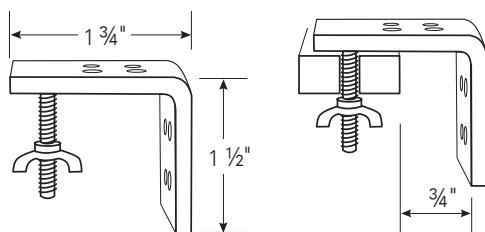

RING SPACING

Rings spaced 7" apart on shade back

STACK HEIGHT

Approximately (all lengths): 8" to 10"

HEAD RAIL DIMENSIONS

Middle support brackets will be supplied for all shades over 41" wide.

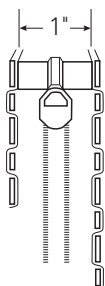

NARROW HEAD RAIL

- (Custom Order Only)
- Standard Shades
 - Waterfall Shades

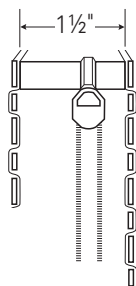

STANDARD HEAD RAIL

- Standard Shades
- Waterfall Shades
- TDBU Shades

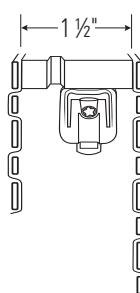

CORDLESS HEAD RAIL

- Standard Shades
- Waterfall Shades

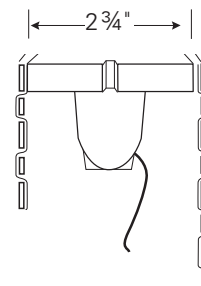

MOTORIZED HEAD RAIL REMOTE OR WAND CONTROL

- Standard Shades
- Waterfall Shades

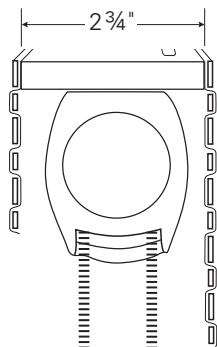

CLUTCH SHADE

with Continuous Cord Loop (shown)

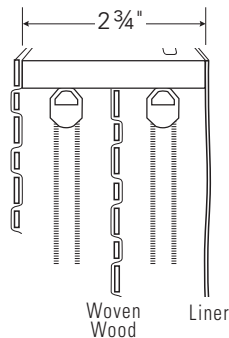

STANDARD TWIN SHADE

Controls Same Side (shown) or Opposite Sides

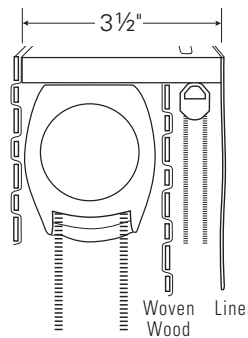

TWIN SHADE w/CLUTCH

(Clutch Control for Front Shade Only) Controls Same Side (shown) or Opposite Sides

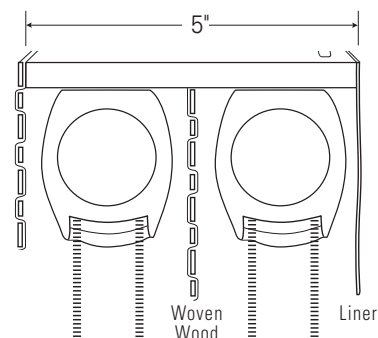

TWIN SHADE w/2 CLUTCHES

Controls Same Side (shown) or Opposite Sides

SLIDING PANELS

Sliding panels provide a clean, contemporary look for large windows and doors. Overlapping panels are suspended from hangers, which glide smoothly on an aluminum track and pass in front of each other, allowing the panels to stack back away from the window. Check the Material Reference table for patterns which are available to be made as Sliding Panels.

The panels are supplied with narrow edge binding to protect them from wear and tear and are custom-sized, based on the ordered width and the number of panels. Sliding panels are operated with wood wands; a center opening sliding panel will have two wands.

NOTE: Bamboo and natural materials can stretch or shrink, so we recommend that panels are ordered with at least $\frac{3}{4}$ " clearance from the ground. Also, when shipped from the factory, panels may be slightly different lengths (up to $\frac{1}{2}$ " from the ordered length). Shorter panels can be made longer by gently pulling on the bottom of the panel until they are the same length as longer panels.

NO CHARGE OPTIONS

ONE-WAY OPENING

When open, all of the panels stack back to either the right or the left. Specify on the order form which side of the window the panels will stack to.

NOTE: If you want the panels to stack completely away from the window for an unobstructed view, allow for the panel width in the overall width of the shade. See "Specifications" for more details.

The standard configuration is for the front panel to be stationary and all other panels stack behind it. Reverse stacking is available upon request, with the rear panel stationary. Free-floating panels are also available.

CENTER OPENING

Center-opening (or split draw) sliding panels must be made with an even number of panels and the panels will stack back to both sides.

The standard configuration is for the front panel on each side to be stationary, and the other panels stack behind it. Reverse stacking is available upon request, with the rear panel stationary. Free-floating panels are also available.

SLIDING PANEL SURCHARGE OPTIONS

LINERS

Available in privacy or black-out, and sewn under the edge binding on all four panel sides.

VALANCE

Valances are 8" long and attached to the front and sides of the track by velcro. If a valance is part of the original sliding panel order, the velcro for the valance will be riveted to the front of the track to ensure a lasting bond.

Valances are cut up the roll, so they wrap around the ends of the track. This means the valance material is rail-roaded and will be oriented differently to the panels. For inside mount sliding panels, the valance will cover the front of the track only. For outside mount sliding panels the valance will be made to wrap around both ends of the track.

When ordered separately, both velcro halves are provided, but the bond between the velcro and the track will not be as durable.

WIDE EDGE BINDING

Panels will come with narrow (1") edge binding as standard, which means that $\frac{1}{2}$ " is visible on the face of the panels. Wide (3") edge binding is also available in the same colors as a surcharge option.

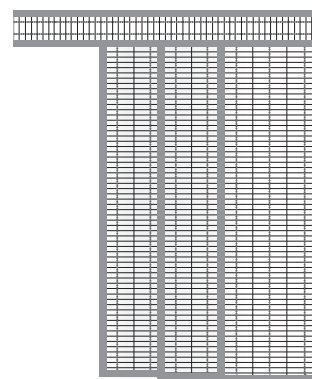

One-Way Right Stacked

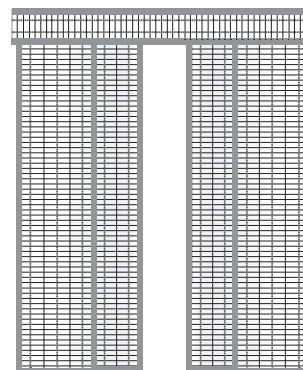

Center Opening

SLIDING PANEL SPECIFICATIONS

SIZE LIMITATIONS

Minimum Width: 48" Minimum Height: 24"
 Maximum Width: 144" Maximum Height: 108"

Tracks wider than 100" are spliced to avoid oversize freight charges.

STANDARD PANEL CONFIGURATIONS

WIDTH	TYPE OF OPENING	# OF PANELS	TRACK TYPE
48" – 84"	One-Way	3 Panels	3 Channel
	Center Opening	4 Panels	4 Channel
84 ¼" – 120"	One-Way	4 Panels	4 Channel
	Center Opening	4 Panels	4 Channel
120 ¼" – 144"	One-Way	5 Panels	5 Channel
	Center Opening	6 Panels	3 Channel

TYPICAL PANEL SIZES (OUTSIDE MOUNT SHADE)

WIDTH	ONE-WAY DRAW		CENTER OPENING	
60"	3 panels	22 ¼"	4 panels	17 ¾"
72"	3 panels	26 ¼"	4 panels	20 ¾"
84"	3 panels	30 ¼"	4 panels	23 ¾"
96"	4 panels	26 ¾"	4 panels	26 ¾"
108"	4 panels	29 ¾"	4 panels	29 ¾"
120"	4 panels	32 ¾"	4 panels	32 ¾"
132"	5 panels	28 ¾"	6 panels	24 ¾"
144"	5 panels	31 ¾"	6 panels	26 ¾"

PANEL SIZE CALCULATIONS

To calculate the approximate panel width, use the ordered width and the number of panels.

Deduct one from the number of panels and multiply this number by 2.5. Then add this number to the ordered width and divide the resulting number by the number of panels.

For example: For a sliding panel order with an 80" width and 5 panels, each panel will be approximately 18" wide.

$$5 \text{ (panels)} - 1 = 4$$

$$4 \times 2.5" = 10"$$

$$80" \text{ (ordered width)} + 10" = 90"$$

$$90" / 5 \text{ (panels)} = 18" \text{ panel width}$$

TRACK DIMENSIONS

TRACK DEPTHS	
3 Channel	2"
4 Channel	2 ¾"
5 Channel	3 ¾"

The distance from the top of the track to the top of the panels is 1". The factory will take account of this distance when calculating the panel length.

MOUNTING DEPTHS

	3 TRACK	4 TRACK	5 TRACK
Minimum IB	2"	2 ¾"	3 ¾"
Flush IB	2 ½"	3 ¼"	3 7/8"

Wall or Face Mount: 2 7/8" flat mounting surface required.
(Using L Bracket)

INSIDE MOUNT DEDUCTIONS

IB Deduction (Width): ¼"

IB Deduction (Height): ½"

DISTANCE FROM THE WALL TO THE BACK OF THE TRACK (CLEARANCE)

	3-CHANNEL TRACK	4-CHANNEL TRACK	5-CHANNEL TRACK
Standard Bracket (2 7/8")	1 ¾"	1 ¼"	¾"
Large Bracket (4 ¼")	2 ½"	2 ¾"	1 7/8"

Adding an extension bracket will provide an extra 2 7/8" of clearance from the wall.

Add the track depth to the clearance to calculate the total projection into the room.

PRO DESIGN WOVEN WOOD WARRANTY

WHAT IS COVERED BY THIS WARRANTY?

This woven wood shade is warranted against defects in materials and workmanship, provided that:

1. The product was installed according to the product instructions.
2. Pro Design recommendations were followed regarding limitations and specifications of the product.

Pro Design reserves the right to determine if your shade warrants a repair or partial replacement of any parts. If necessary, Pro Design will replace your shade with a new shade of equal or superior value. This shall be your sole remedy under this warranty.

All motors, remote controls and wand motors are warranted for a period of five years from the date of purchase.

WHO IS COVERED BY THIS WARRANTY?

This warranty applies only to the original retail purchaser with proof of purchase in the USA.

WHAT IS NOT COVERED BY THIS WARRANTY?

Your Pro Design woven wood shade is made from natural materials, which will show natural variations in color, texture and weave. They may also show some fading and discoloration over time, or cracking, twisting, bowing or stretching and shrinkage due to exposure to direct sunlight or excessive moisture. These are not considered defects for the purposes of this warranty.

This warranty does not cover the removal or installation of original or replacement shades. This warranty does not cover damage or defects caused by, or resulting from improper maintenance, neglect or improper use, wear and tear, abuse, neglect, accidents, alteration, commercial use, installation, removal or reinstallation or exposure to excessive moisture.

Failure to follow the proper installation, charging and use instructions will invalidate the warranty for motors, remotes and wand motors.

YOUR RIGHTS UNDER STATE LAW

This warranty gives you specific legal rights. You may also have other rights which may vary from State to State. In no event shall Pro Design be liable for incidental or consequential damages or for any other direct or indirect damage, loss, cost, expense or fee. Some states do not allow the exclusion or limitation of incidental or consequential damages, so the above limitation or exclusion may not apply to you. This warranty is exclusive and in lieu of all other obligations, liabilities or warranties.

WALDEN
PREMIER